

Marks (to be entered by Teacher)

| | | | |
|-------------|-------|-------------|----------------------|
| Punctuality | _____ | | |
| Neatness | _____ | Total | <input type="text"/> |
| Answers | _____ | | |
| Sub-Total | _____ | | |
| Bonus/Prize | _____ | GRAND TOTAL | <input type="text"/> |

A2

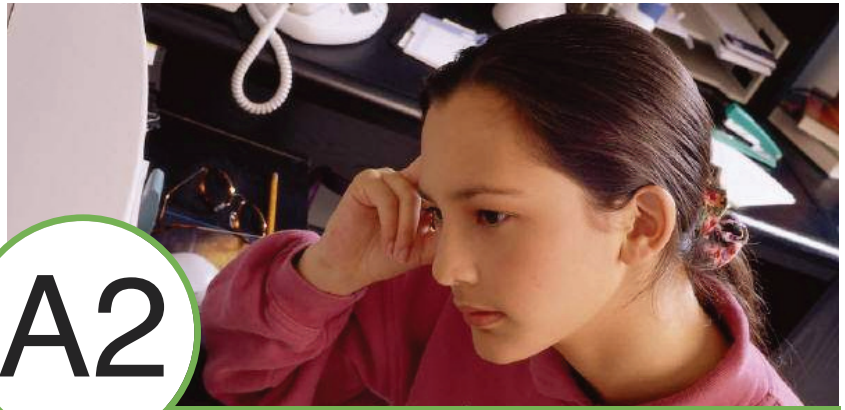

Make sure your name and address are written here.

Name _____

Address _____

Age _____ Date of Birth _____

Class Teacher's Name _____

Bible Searching

Level 3



Lesson No. 1 - Noah and the Flood - Building the Ark



Genesis 6: 5-22



Genesis 6: 8

Do you have rules at school? Often we don't like rules, but they are usually made for our safety and for the good of everyone. When you disobey school rules you can expect to be punished. God is love. He is also holy and just, so He must punish those who disobey His rules. The story of Noah shows what happened to people when they disobeyed God and went their own way.

HOLY means 'being perfect' and JUST means 'being fair'.

What were most people like in Noah's day? Circle the right words.



Wicked

Violent

Loving

Good

Kind

Evil-minded

| | |
|--|---|
| | 3 |
|--|---|

Look at the Bible Reading and write down, IN YOUR OWN WORDS, how God felt when He saw man's great wickedness.

| | |
|--|---|
| | 2 |
|--|---|

What did God decide He would do to punish their wickedness?

Answer **TRUE** or **FALSE**:-

He would make them all suffer illness. _____

He would destroy mankind from the face of the earth. _____

He would bring a flood of waters upon the earth. _____

| | |
|--|---|
| | 3 |
|--|---|

Only one man pleased God.

Write his name in the box under the picture.

He was special to God because he was different from all the other people on the earth.



| | |
|--|---|
| | 1 |
|--|---|

Look at verse 9 in the Bible Reading and give 3 reasons why he pleased God.

| | |
|---|--|
| 1 | |
| 2 | |
| 3 | |

| | |
|--|---|
| | 3 |
|--|---|

Unscramble the letters to find the names of Noah's sons.

HMA

HSME

PHJATEH

| | | |
|--|--|--|
| | | |
|--|--|--|

| | |
|--|---|
| | 3 |
|--|---|

God told Noah to build an ark.

What kind of wood was he to use?
Write the answer on the log.

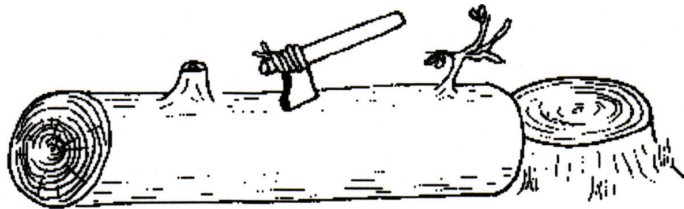

| | |
|--|---|
| | 1 |
|--|---|

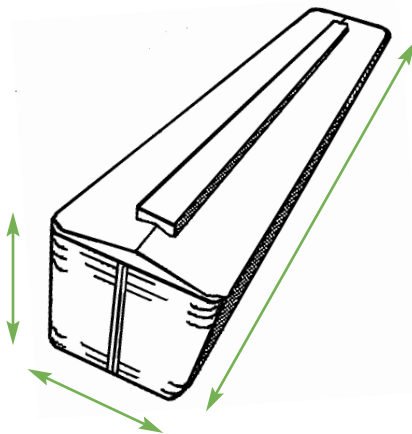

God gave Noah exact measurements and plans for the ark.

Write the measurements beside the arrows on the drawing.

| | |
|--|---|
| | 3 |
|--|---|

How was God going to destroy everything on the earth?

| |
|--|
| |
|--|

| | |
|--|---|
| | 1 |
|--|---|

God had to punish the world because people had turned away from Him and were doing evil. *Noah was saved because he trusted God.* Noah had never seen floods, or even rain, and he was hundreds of miles from the sea. Yet here he was, building a huge boat in the middle of dry land, because God had told him to do so.

It is because God is holy and just that He destroyed everything. He is also love. That's why He told Noah to build the ark so that he and his family could be saved. He trusted and believed God. That is faith. We all deserve to be punished for our sin but God is ready to save us, when we trust in the Lord Jesus Christ as our own personal Saviour.

For teacher's remarks

| |
|-------|
| Total |
| 20 |

Lesson No. 2 - Noah and the Flood - Into the Ark



Genesis 7: 1-20

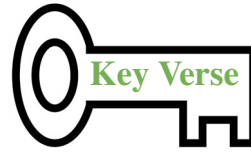

Genesis 7: 5

Please put your name here

How do your family members show you that they love you? As well as feeding and caring for you, they teach you the right way to do things. This sometimes means that you're told off when you do wrong. Part of showing your family that you love them is to do as they tell you. Noah showed how much he loved God by obeying Him. He did exactly what God told him to do.

Write out the **Key Verse**.

| | |
|--|---|
| | 2 |
|--|---|

Draw a line from each question to the correct number.

(If possible use a different colour for each line.)

How many women went into the ark?

For how many days and nights was it to rain?

How many doors were in the ark? (See **Genesis 6: 16**.)

How many sons did Noah have?

How many people altogether were in the ark?

1
40
3
8
4

| | |
|--|---|
| | 5 |
|--|---|



How old was Noah when the flood covered the earth?

100 600 200 120 500

Write the correct number below Noah's beard.

| | |
|--|---|
| | 1 |
|--|---|

What interval of time passed between God telling Noah to enter the ark, and the flood actually beginning?

| | |
|--|---|
| | 1 |
|--|---|

Write in the number of the month and put a circle around the day when the flood came.

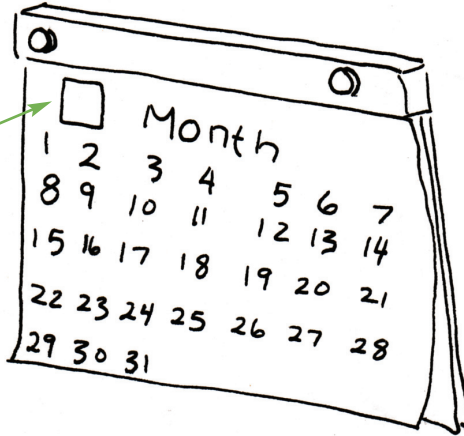

| | |
|--|---|
| | 2 |
|--|---|

How far above the mountains did the water rise?

| | |
|--|---|
| | 1 |
|--|---|

WORD PUZZLE

Write the answers to the clues below, AND then circle them in the Word Puzzle. They are hidden up, down, and across.

| | | | | | |
|---|---|---|---|---|---|
| F | A | N | O | A | H |
| O | L | W | A | Y | S |
| R | R | A | I | N | D |
| T | A | O | B | E | A |
| Y | R | H | A | M | Y |
| Y | K | G | O | D | S |

1. He obeyed God. _ _ _ _ _
2. The number of nights it rained. _ _ _ _ _
3. This fell from the sky. _ _ _ _ _
4. It rained both _ _ _ _ and nights.
5. The brother of Shem and Japheth. _ _ _ _
6. He built this. _ _ _ _

| | |
|--|---|
| | 6 |
|--|---|

Write the remaining letters in the box below, to find something we should remember to do.

_ _ _ _ _ _ _ _ _ _ _ _ _ _ _

| | |
|--|---|
| | 2 |
|--|---|

God saved Noah because he obeyed Him by building the ark and entering into it, as God told him. God wants to save us too. As God invited Noah into the ark to be saved from the flood, so He invites us to trust the Lord Jesus in order to be saved from our sins.

Can you think of any ways God has shown His love to you?

Write your answer here.

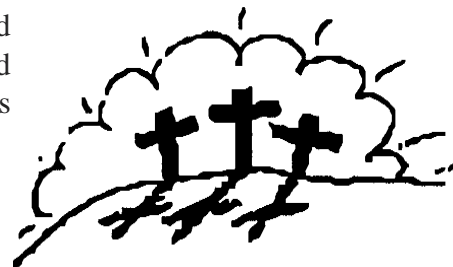

For teacher's remarks

| |
|-------|
| Total |
| 20 |

Lesson No. 3 - Noah and the Flood - Saved by the Ark



Genesis 8: 1-22



Genesis 8: 1

Please put your name here

Did you ever wake up in the middle of the night and feel very frightened? It is at times like that you're glad you have someone looking after you. We need the care and protection of those who love us. The Bible says God looks after those who trust in Him. He certainly did this for Noah when the great flood came.

Finish writing the letters to find out what happened after the waters had flooded the earth for 150 days.



| | |
|--|---|
| | 1 |
|--|---|

What did God send to make the waters go down? Shade in the correct weather symbol.

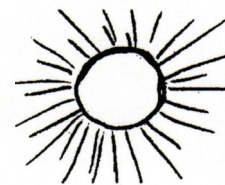
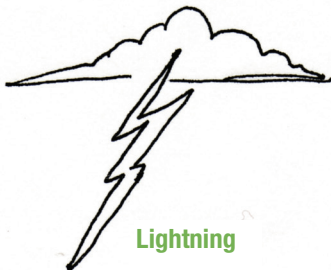

| | |
|--|---|
| | 1 |
|--|---|

Using the Bible Reading, do this crossword.

CROSSWORD

Clues Across

- The mountain the ark rested on.
- The second bird Noah sent out.
- The number of days Noah waited before sending the second bird again.

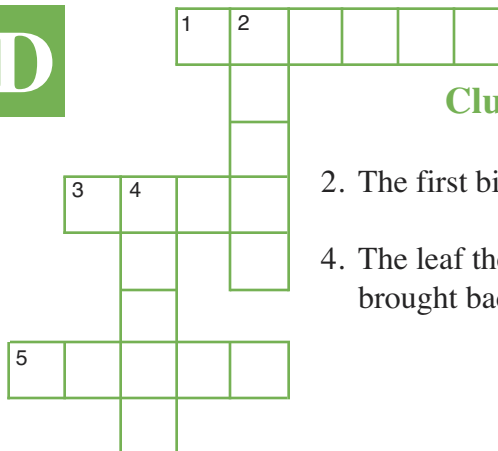

Clues Down

- The first bird Noah sent out.
- The leaf the second bird brought back.

| | |
|--|---|
| | 5 |
|--|---|

Fill in the missing numbers from verse 13.

The water had dried up by the _____ day of the _____ month,
and Noah was _____ years old.

| | |
|--|---|
| | 3 |
|--|---|

Which verse in the Bible Reading tells us the earth was dry?

| |
|-------|
| Verse |
|-------|

| | |
|--|---|
| | 1 |
|--|---|

When the flood was over, what did God tell Noah to do?

| | |
|--|---|
| | 1 |
|--|---|

What did Noah do when he, and his family, had come out of the ark?

Put a ✓ next to the right answers, and an ✗ next to the wrong answers.

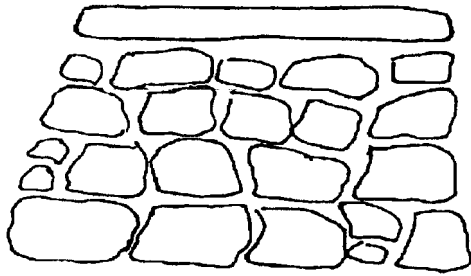

He built a house for his family.

He built an altar to the Lord.

He went exploring for food.

He sacrificed burnt offerings to the Lord.

| | |
|--|---|
| | 4 |
|--|---|

The ark saved Noah from the flood, which was God’s punishment for man’s sin. We can be saved from the punishment for our sin because the Lord Jesus suffered in our place, when He died on the cross.

Look at God’s promise in verse 22 of the Bible Reading, and write under each pair of pictures the part of the verse that suits it best.

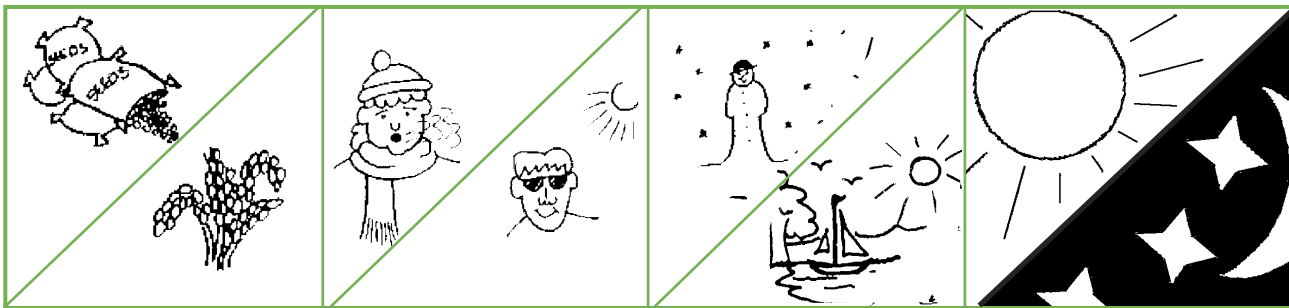

| | |
|--|---|
| | 4 |
|--|---|

No problem is too big or too small for us to tell Him about. If you ask God to save you, He will always help you.

For teacher’s remarks

| |
|---------------|
| Total 20 |
|---------------|

Lesson No. 4 - Noah and the Flood - Out of the Ark



Genesis 9: 7-17



Genesis 9: 15

Please put your name here

What does it mean to make a promise? We usually say, "I promise", if we intend to make every possible effort to do as we have said.

Has anyone ever broken a promise to you? It's very hurtful when this happens.

God never breaks His promises.

This part of the story is all about God's promise to Noah and his descendants.

What did God tell Noah to do? Answer **YES** or **NO**:-

Increase in number and fill the earth.

Build a home for your family.

Build another ark.

| | |
|--|---|
| | 3 |
|--|---|

Write down the first letter of each picture to discover another word that means the same as COVENANT. (Verse 9)



| | |
|--|---|
| | 1 |
|--|---|

Look at verse 12.

With whom did God make His covenant? Write the answers below these two pictures.





| | |
|--|---|
| | 2 |
|--|---|

Draw the sign of God’s promise in the box below. Make your picture as colourful as possible.

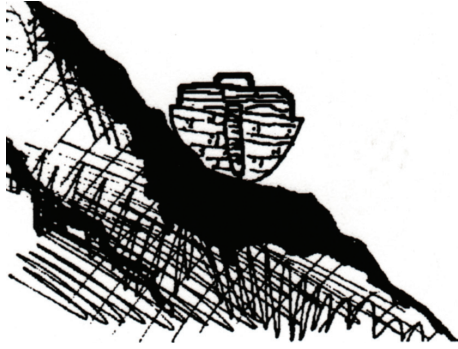

| | |
|--|---|
| | 2 |
|--|---|

Write out the **Key Verse**.

| | |
|--|---|
| | 2 |
|--|---|

For how long was this covenant going to last? Circle the right answer.

Until Noah died

Forever

For a few years

| | |
|--|---|
| | 1 |
|--|---|

| | | | | | | | |
|---|---|---|---|---|---|---|---|
| T | N | A | N | E | V | O | C |
| H | C | L | O | U | D | S | R |
| A | G | O | D | K | E | E | A |
| O | R | E | V | E | N | P | I |
| N | S | H | I | S | P | R | N |
| F | O | R | E | V | E | R | B |
| O | F | L | O | O | D | M | O |
| I | S | E | S | A | L | L | W |

COVENANT
RAINBOW
CLOUDS
NOAH
NEVER
FLOOD
FOREVER
ALL

Word Puzzle

Colour or shade these words which are written backwards, forwards, up and down in the Word Puzzle.

Write out the remaining letters to find out something God always does.

| | |
|--|---|
| | 9 |
|--|---|

God promised that He would never flood the whole world again, but He must still punish sinners by separating them from Himself. Today if we believe that the Lord Jesus died for us, God promises we shall be saved forever.

Return your lessons to:

For student’s comments or teacher’s remarks

Total
| 20

or the PBS Centre below